

BPE Code	Surface Finish Roughness Average (Ra)
SFF0	Unpolished ID and OD, not third-party inspected
SFF1	20 $\mu\text{in.}$ (0.51 μm) max polished ID, unpolished OD
SFF1	20 $\mu\text{in.}$ (0.51 μm) max polished ID, 40 $\mu\text{in.}$ (1.0 μm) max polished OD
SFF4	15 $\mu\text{in.}$ (0.38 μm) max electropolished ID, unpolished OD
SFF4	15 $\mu\text{in.}$ (0.38 μm) max electropolished ID, 32 $\mu\text{in.}$ (0.81 μm) max polished OD

DT1 BPE Tube

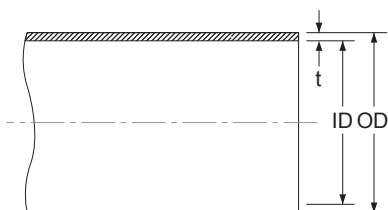

Size(Inch)	OD	ID	t
0.25"	6.35	4.57	0.89
0.375"	9.53	7.75	0.89
0.50"	12.70	9.40	1.65
0.75"	19.05	15.75	1.65
1.0"	25.40	22.10	1.65
1.5"	38.10	34.80	1.65
2.0"	50.80	47.50	1.65
2.5"	63.50	60.20	1.65
3.0"	76.20	72.90	1.65
4.0"	101.60	97.38	2.11
6.0"	152.40	146.86	2.77

DT-4.1.1-1(DT7)

Automatic Tube Weld: 90° Elbow[ww]

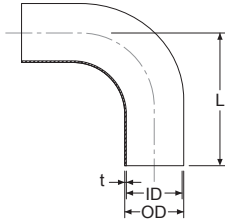

Size(Inch)	OD/IDxt	L
0.5"	12.70 / 9.40 x 1.65	76.2
0.75"	19.05 / 15.75 x 1.65	76.2
1.0"	25.40 / 22.10 x 1.65	76.2
1.5"	38.10 / 34.80 x 1.65	95.3
2.0"	50.80 / 47.50 x 1.65	120.7
2.5"	63.50 / 60.20 x 1.65	139.7
3.0"	76.20 / 72.90 x 1.65	158.8
4.0"	101.60 / 97.40 x 2.11	203.2

DT-4.1.1-4(DT8)

Automatic Tube Weld: 45° Elbow[ww]

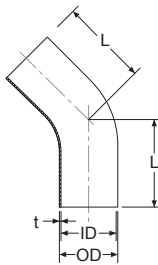

Size(Inch)	OD/IDxt	L
0.5"	12.70 / 9.40 x 1.65	57.2
0.75"	19.05 / 15.75 x 1.65	57.2
1.0"	25.40 / 22.10 x 1.65	57.2
1.5"	38.10 / 34.80 x 1.65	63.5
2.0"	50.80 / 47.50 x 1.65	76.2
2.5"	63.50 / 60.20 x 1.65	85.7
3.0"	76.20 / 72.90 x 1.65	92.1
4.0"	101.60 / 97.40 x 2.11	114.3

DT-4.1.2-1(DT9)

Automatic Tube Weld: Straight Tee&Cross

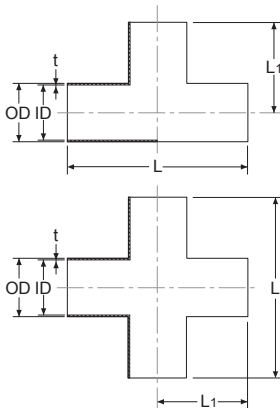

Size(Inch)	OD/IDxt	L	L1
0.5"	12.70 / 9.40 x 1.65	95.2	47.6
0.75"	19.05 / 15.75 x 1.65	101.6	50.8
1.0"	25.40 / 22.10 x 1.65	108.0	54
1.5"	38.10 / 34.80 x 1.65	120.6	60.3
2.0"	50.80 / 47.50 x 1.65	146.0	73
2.5"	63.50 / 60.20 x 1.65	158.8	79.4
3.0"	76.20 / 72.90 x 1.65	171.4	85.7
4.0"	101.60 / 97.40 x 2.11	209.6	104.8

DT-4.1.2-6(DT10)

Automatic Tube Weld: Reducing Tee

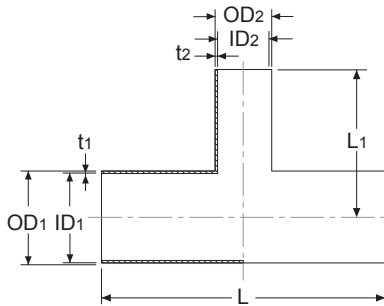

Size (Inch)	OD1 / ID1 x t1	OD2 / ID2 x t2	L	L1
0.75"x0.5"	19.05/15.75x1.65	12.70/9.40x1.65	101.6	50.8
1.0"x0.5"	25.40/22.10x1.65	12.70/9.40x1.65	108	54
1.0"x0.75"	25.40/22.10x1.65	19.05/15.75x1.65	108	54
1.5"x0.5"	38.10/34.80x1.65	12.70/9.40x1.65	120.6	60.3
1.5"x0.75"	38.10/34.80x1.65	19.05/15.75x1.65	120.6	60.3
1.5"x1.0"	38.10/34.80x1.65	25.40/22.10x1.65	120.6	60.3
2.0"x0.5"	50.80/47.50x1.65	12.70/9.40x1.65	146	66.7
2.0"x0.75"	50.80/47.50x1.65	19.05/15.75x1.65	146	66.7
2.0"x1.0"	50.80/47.50x1.65	25.40/22.10x1.65	146	66.7
2.0"x1.5"	50.80/47.50x1.65	38.10/34.80x1.65	146	66.7
2.5"x0.5"	63.50/60.20x1.65	12.70/9.40x1.65	158.8	73
2.5"x0.75"	63.50/60.20x1.65	19.05/15.75x1.65	158.8	73
2.5"x1.0"	63.50/60.20x1.65	25.40/22.10x1.65	158.8	73
2.5"x1.5"	63.50/60.20x1.65	38.10/34.80x1.65	158.8	73
2.5"x2.0"	63.50/60.20x1.65	50.80/47.50x1.65	158.8	73
3.0"x0.5"	76.20/72.90x1.65	12.70/9.40x1.65	171.4	79.4
3.0"x0.75"	76.20/72.90x1.65	19.05/15.75x1.65	171.4	79.4
3.0"x1.0"	76.20/72.90x1.65	25.40/22.10x1.65	171.4	79.4
3.0"x1.5"	76.20/72.90x1.65	38.10/34.80x1.65	171.4	79.4
3.0"x2.0"	76.20/72.90x1.65	50.80/47.50x1.65	171.4	79.4
3.0"x2.5"	76.20/72.90x1.65	63.50/60.20x1.65	171.4	79.4
4.0"x1.0"	101.60/97.40x2.11	25.40/22.10x1.65	209.6	92.1
4.0"x1.5"	101.60/97.40x2.11	38.10/34.80x1.65	209.6	92.1
4.0"x2.0"	101.60/97.40x2.11	50.80/47.50x1.65	209.6	98.4
4.0"x2.5"	101.60/97.40x2.11	63.50/60.20x1.65	209.6	98.4
4.0"x3.0"	101.60/97.40x2.11	76.20/72.90x1.65	209.6	98.4

DT-4.1.3-[a](DT11)

Automatic Tube Weld: Concentric & Eccentric Reducer

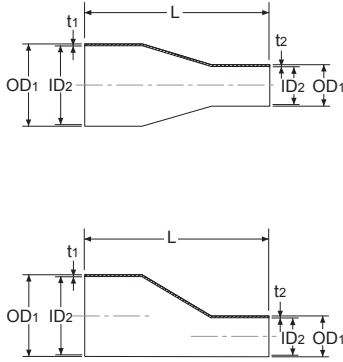

Size (Inch)	OD1 / ID1 x t1	OD2 / ID2 x t2	L
0.75"x0.5"	19.05/15.75x1.65	12.70/9.40x1.65	101.6
1.0"x0.5"	25.40/22.10x1.65	12.70/9.40x1.65	114.3
1.0"x0.75"	25.40/22.10x1.65	19.05/15.75x1.65	101.6
1.5"x0.5"	38.10/34.80x1.65	12.70/9.40x1.65	139.7
1.5"x0.75"	38.10/34.80x1.65	19.05/15.75x1.65	127
1.5"x1.0"	38.10/34.80x1.65	25.40/22.10x1.65	127
2.0"x0.5"	50.80/47.50x1.65	12.70/9.40x1.65	196.9
2.0"x0.75"	50.80/47.50x1.65	19.05/15.75x1.65	184.2
2.0"x1.0"	50.80/47.50x1.65	25.40/22.10x1.65	184.2
2.0"x1.5"	50.80/47.50x1.65	38.10/34.80x1.65	133.4
2.5"x1.5"	63.50/60.20x1.65	38.10/34.80x1.65	184.2
2.5"x2.0"	63.50/60.20x1.65	50.80/47.50x1.65	139.7
3.0"x1.5"	76.20/72.90x1.65	38.10/34.80x1.65	235
3.0"x2.0"	76.20/72.90x1.65	50.80/47.50x1.65	190.5
3.0"x2.5"	76.20/72.90x1.65	63.50/60.20x1.65	139.7
4.0"x1.5"	101.60/97.40x2.11	38.10/34.80x1.65	342.9
4.0"x2.0"	101.60/97.40x2.11	50.80/47.50x1.65	298.5
4.0"x2.5"	101.60/97.40x2.11	63.50/60.20x1.65	247.7
4.0"x3.0"	101.60/97.40x2.11	76.20/72.90x1.65	196.9

DT-4.1.1-2(DT12)

Automatic Tube Weld: Hygienic Clamp Joint 90° Elbow

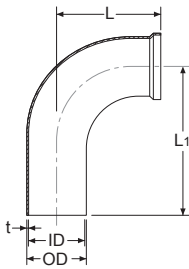

Size(Inch)	OD/IDxt	L	L1
0.5"	12.70/9.40x1.65	41.3	76.2
0.75"	19.05/15.75x1.65	41.3	76.2
1.0"	25.40/22.10x1.65	50.8	76.2
1.5"	38.10/34.80x1.65	69.9	95.3
2.0"	50.80/47.50x1.65	88.9	120.7
2.5"	63.50/60.20x1.65	108.0	139.7
3.0"	76.20/72.90x1.65	127.0	158.8
4.0"	101.60/97.40x2.11	168.3	203.2

DT-4.1.3-[b]

Automatic Tube Weld: Concentric & Eccentric Reducer

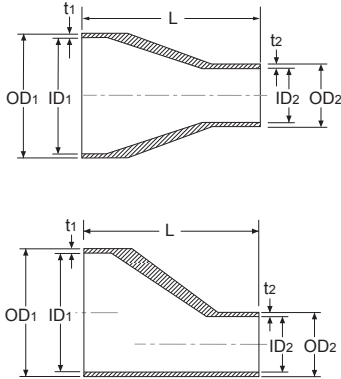

Size (Inch)	OD1 / ID1 x t1	OD2 / ID2 x t2	L
0.75"x0.5"	19.05/15.75x1.65	12.70/9.40x1.65	54.0
1.0"x0.5"	25.40/22.10x1.65	12.70/9.40x1.65	63.5
1.0"x0.75"	25.40/22.10x1.65	19.05/15.75x1.65	54.0
1.5"x0.75"	38.10/34.80x1.65	19.05/15.75x1.65	76.2
1.5"x1.0"	38.10/34.80x1.65	25.40/22.10x1.65	63.5
2.0"x1.0"	50.80/47.50x1.65	25.40/22.10x1.65	85.7
2.0"x1.5"	50.80/47.50x1.65	38.10/34.80x1.65	63.5
2.5"x1.5"	63.50/60.20x1.65	38.10/34.80x1.65	85.7
2.5"x2.0"	63.50/60.20x1.65	50.80/47.50x1.65	63.5
3.0"x1.5"	76.20/72.90x1.65	38.10/34.80x1.65	108.0
3.0"x2.0"	76.20/72.90x1.65	50.80/47.50x1.65	85.7
3.0"x2.5"	76.20/72.90x1.65	63.50/60.20x1.65	66.7
4.0"x2.0"	101.60/97.40x2.11	50.80/47.50x1.65	130.2
4.0"x2.5"	101.60/97.40x2.11	63.50/60.20x1.65	108.0
4.0"x3.0"	101.60/97.40x2.11	76.20/72.90x1.65	98.4

DT-4.1.1-5(DT13)

Automatic Tube Weld: Hygienic Clamp Joint 45° Elbow

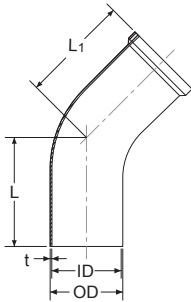

Size(Inch)	OD/IDxt	L	L1
0.5"	12.70/9.40x1.65	57.2	25.4
0.75"	19.05/15.75x1.65	57.2	25.4
1.0"	25.40/22.10x1.65	57.2	28.6
1.5"	38.10/34.80x1.65	63.5	36.5
2.0"	50.80/47.50x1.65	76.2	44.5
2.5"	63.50/60.20x1.65	85.7	52.4
3.0"	76.20/72.90x1.65	92.1	60.3
4.0"	101.60/97.40x2.11	114.3	79.4

DT-4.1.2-7(DT14)

Automatic Tube Weld: Short Outlet Hygienic Clamp Joint Reducing Tee

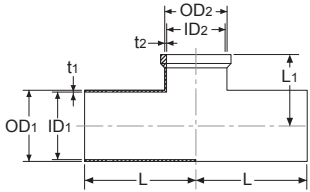

Size (Inch)	OD1 / ID1 x t1	OD2 / ID2 x t2	L	L1
0.75"x0.5"	19.05/15.75x1.65	12.70/9.40x1.65	50.8	25.4
1.0"x0.5"	25.40/22.10x1.65	12.70/9.40x1.65	54.0	28.6
1.0"x0.75"	25.40/22.10x1.65	19.05/15.75x1.65	54.0	28.6
1.5"x0.5"	38.10/34.80x1.65	12.70/9.40x1.65	60.3	34.9
1.5"x0.75"	38.10/34.80x1.65	19.05/15.75x1.65	60.3	34.9
1.5"x1.0"	38.10/34.80x1.65	25.40/22.10x1.65	60.3	34.9
2.0"x0.5"	50.80/47.50x1.65	12.70/9.40x1.65	73.0	41.3
2.0"x0.75"	50.80/47.50x1.65	19.05/15.75x1.65	73.0	41.3
2.0"x1.0"	50.80/47.50x1.65	25.40/22.10x1.65	73.0	41.3
2.0"x1.5"	50.80/47.50x1.65	38.10/34.80x1.65	73.0	41.3
2.5"x0.5"	63.50/60.20x1.65	12.70/9.40x1.65	79.4	47.6
2.5"x0.75"	63.50/60.20x1.65	19.05/15.75x1.65	79.4	47.6
2.5"x1.0"	63.50/60.20x1.65	25.40/22.10x1.65	79.4	47.6
2.5"x1.5"	63.50/60.20x1.65	38.10/34.80x1.65	79.4	47.6
2.5"x2.0"	63.50/60.20x1.65	50.80/47.50x1.65	79.4	47.6
3.0"x0.5"	76.20/72.90x1.65	12.70/9.40x1.65	85.7	54.0
3.0"x0.75"	76.20/72.90x1.65	19.05/15.75x1.65	85.7	54.0
3.0"x1.0"	76.20/72.90x1.65	25.40/22.10x1.65	85.7	54.0
3.0"x1.5"	76.20/72.90x1.65	38.10/34.80x1.65	85.7	54.0
3.0"x2.0"	76.20/72.90x1.65	50.80/47.50x1.65	85.7	54.0
3.0"x2.5"	76.20/72.90x1.65	63.50/60.20x1.65	85.7	54.0
4.0"x1.0"	101.60/97.40x2.11	25.40/22.10x1.65	104.8	66.7
4.0"x1.5"	101.60/97.40x2.11	38.10/34.80x1.65	104.8	66.7
4.0"x2.0"	101.60/97.40x2.11	50.80/47.50x1.65	104.8	66.7
4.0"x2.5"	101.60/97.40x2.11	63.50/60.20x1.65	104.8	66.7
4.0"x3.0"	101.60/97.40x2.11	76.20/72.90x1.65	104.8	66.7

DT-4.1.2-2(DT15)

Automatic Tube Weld: Short Outlet Hygienic Clamp Joint Tee

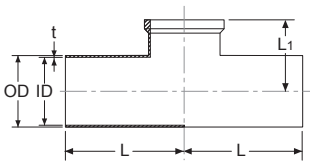

Size(Inch)	OD/IDxt	L	L1
0.5"	12.70/9.40x1.65	47.6	25.4
0.75"	19.05/15.75x1.65	50.8	28.6
1.0"	25.40/22.10x1.65	54.0	28.6
1.5"	38.10/34.80x1.65	60.3	34.9
2.0"	50.80/47.50x1.65	73.0	41.3
2.5"	63.50/60.20x1.65	79.4	47.6
3.0"	76.20/72.90x1.65	85.7	54
4.0"	101.60/97.40x2.11	104.8	69.9



DT-4.1.1-3(DT16)

Hygienic Clamp Joint: 90° Elbow

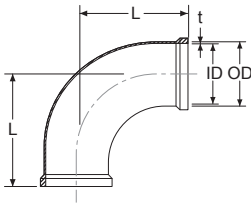

Size(Inch)	OD/IDxt	L
0.5"	12.70 / 9.40 x 1.65	41.3
0.75"	19.05 / 15.75 x 1.65	41.3
1.0"	25.40 / 22.10 x 1.65	50.8
1.5"	38.10 / 34.80 x 1.65	69.9
2.0"	50.80 / 47.50 x 1.65	88.9
2.5"	63.50 / 60.20 x 1.65	108.0
3.0"	76.20 / 72.90 x 1.65	127.0
4.0"	101.60 / 97.40 x 2.11	168.3

DT-4.1.1-6(DT17)

Hygienic Clamp Joint: 45° Elbow

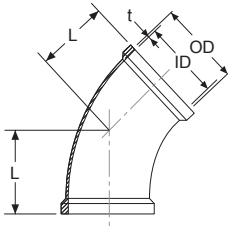

Size(Inch)	OD/IDxt	L
0.5"	12.70 / 9.40 x 1.65	25.4
0.75"	19.05 / 15.75 x 1.65	25.4
1.0"	25.40 / 22.10 x 1.65	28.6
1.5"	38.10 / 34.80 x 1.65	36.5
2.0"	50.80 / 47.50 x 1.65	44.5
2.5"	63.50 / 60.20 x 1.65	52.4
3.0"	76.20 / 72.90 x 1.65	60.3
4.0"	101.60 / 97.40 x 2.11	79.4

DT-4.1.2-4(DT18)

Hygienic Clamp Joint: Short Tee & Cross

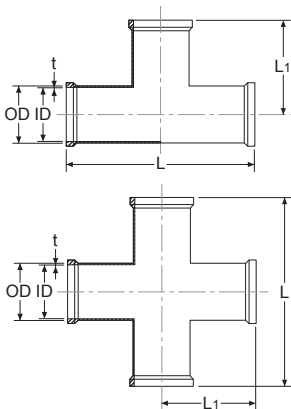

Size(Inch)	OD/IDxt	L	L1
0.5"	12.70 / 9.40 x 1.65	114.4	57.2
0.75"	19.05 / 15.75 x 1.65	120.6	60.3
1.0"	25.40 / 22.10 x 1.65	133.4	66.7
1.5"	38.10 / 34.80 x 1.65	146.0	73
2.0"	50.80 / 47.50 x 1.65	171.4	85.7
2.5"	63.50 / 60.20 x 1.65	184.2	92.1
3.0"	76.20 / 72.90 x 1.65	196.8	98.4
4.0"	101.60 / 97.40 x 2.11	241.4	120.7

DT-4.1.2-8(DT19)
 Hygienic Clamp Joint: Reducing Tee

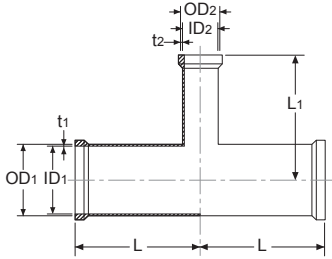

Size (Inch)	OD1 / ID1 x t1	OD2 / ID2 x t2	L	L1
0.75"x0.5"	19.05/15.75x1.65	12.70/9.40x1.65	63.5	63.5
1.0"x0.5"	25.40/22.10x1.65	12.70/9.40x1.65	66.7	66.7
1.0"x0.75"	25.40/22.10x1.65	19.05/15.75x1.65	66.7	66.7
1.5"x0.5"	38.10/34.80x1.65	12.70/9.40x1.65	73.0	73.0
1.5"x0.75"	38.10/34.80x1.65	19.05/15.75x1.65	73.0	73.0
1.5"x1.0"	38.10/34.80x1.65	25.40/22.10x1.65	73.0	73.0
2.0"x1.0"	50.80/47.50x1.65	25.40/22.10x1.65	85.7	79.4
2.0"x1.5"	50.80/47.50x1.65	38.10/34.80x1.65	85.7	79.4
2.5"x1.0"	63.50/60.20x1.65	25.40/22.10x1.65	92.1	85.7
2.5"x1.5"	63.50/60.20x1.65	38.10/34.80x1.65	92.1	85.7
2.5"x2.0"	63.50/60.20x1.65	50.80/47.50x1.65	92.1	85.7
3.0"x1.0"	76.20/72.90x1.65	25.40/22.10x1.65	98.4	92.1
3.0"x1.5"	76.20/72.90x1.65	38.10/34.80x1.65	98.4	92.1
3.0"x2.0"	76.20/72.90x1.65	50.80/47.50x1.65	98.4	92.1
3.0"x2.5"	76.20/72.90x1.65	63.50/60.20x1.65	98.4	92.1
4.0"x1.0"	101.60/97.40x2.11	25.40/22.10x1.65	120.7	104.8
4.0"x1.5"	101.60/97.40x2.11	38.10/34.80x1.65	120.7	104.8
4.0"x2.0"	101.60/97.40x2.11	50.80/47.50x1.65	120.7	111.1
4.0"x2.5"	101.60/97.40x2.11	63.50/60.20x1.65	120.7	111.1
4.0"x3.0"	101.60/97.40x2.11	76.20/72.90x1.65	120.7	111.1

DT-4.1.1-7(DT23)
 Automatic Tube Weld: 180° Return Bend

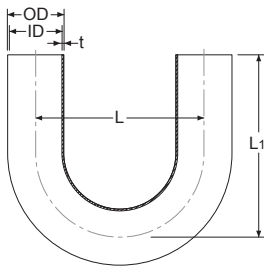

Size(Inch)	OD/IDxt	L	L1
0.5"	12.70/9.40x1.65	114.3	76.2
0.75"	19.05/15.75x1.65	114.3	76.2
1.0"	25.40/22.10x1.65	76.2	76.2
1.5"	38.10/34.80x1.65	114.3	114.3
2.0"	50.80/47.50x1.65	152.4	127.0
2.5"	63.50/60.20x1.65	190.5	146.1
3.0"	76.20/72.90x1.65	228.6	165.1
4.0"	101.60/97.40x2.11	304.8	215.9

DT-4.1.2-9(DT20)

Hygienic Clamp Joint: Short Outlet Reducing Tee

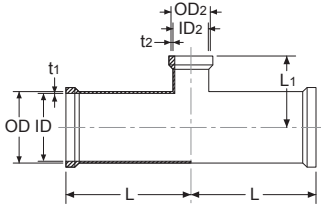

Size (Inch)	OD1 / ID1 x t1	OD2 / ID2 x t2	L	L1
0.75"x0.5"	19.05/15.75x1.65	12.70/9.40x1.65	63.5	25.4
1.0"x0.5"	25.40/22.10x1.65	12.70/9.40x1.65	66.7	28.6
1.0"x0.75"	25.40/22.10x1.65	19.05/15.75x1.65	66.7	28.6
1.5"x0.5"	38.10/34.80x1.65	12.70/9.40x1.65	73.0	34.9
1.5"x0.75"	38.10/34.80x1.65	19.05/15.75x1.65	73.0	34.9
1.5"x1.0"	38.10/34.80x1.65	25.40/22.10x1.65	73.0	34.9
2.0"x1.0"	50.80/47.50x1.65	25.40/22.10x1.65	85.7	41.3
2.0"x1.5"	50.80/47.50x1.65	38.10/34.80x1.65	85.7	41.3
2.5"x1.0"	63.50/60.20x1.65	25.40/22.10x1.65	92.1	47.6
2.5"x1.5"	63.50/60.20x1.65	38.10/34.80x1.65	92.1	47.6
2.5"x2.0"	63.50/60.20x1.65	50.80/47.50x1.65	92.1	47.6
3.0"x1.0"	76.20/72.90x1.65	25.40/22.10x1.65	98.4	54.0
3.0"x1.5"	76.20/72.90x1.65	38.10/34.80x1.65	98.4	54.0
3.0"x2.0"	76.20/72.90x1.65	50.80/47.50x1.65	98.4	54.0
3.0"x2.5"	76.20/72.90x1.65	63.50/60.20x1.65	98.4	54.0
4.0"x1.0"	101.60/97.40x2.11	25.40/22.10x1.65	120.7	66.7
4.0"x1.5"	101.60/97.40x2.11	38.10/34.80x1.65	120.7	66.7
4.0"x2.0"	101.60/97.40x2.11	50.80/47.50x1.65	120.7	66.7
4.0"x2.5"	101.60/97.40x2.11	63.50/60.20x1.65	120.7	66.7
4.0"x3.0"	101.60/97.40x2.11	76.20/72.90x1.65	120.7	66.7

DT-4.1.1-8(DT24)

Hygienic Clamp Joint: 180° Return Bend

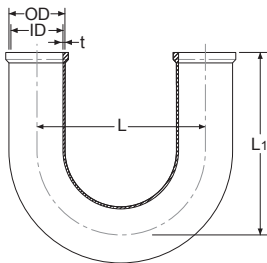

Size(Inch)	OD/IDxt	L	L1
0.5"	12.70/9.40x1.65	114.3	88.9
0.75"	19.05/15.75x1.65	114.3	88.9
1.0"	25.40/22.10x1.65	76.2	88.9
1.5"	38.10/34.80x1.65	114.3	127.0
2.0"	50.80/47.50x1.65	152.4	139.7
2.5"	63.50/60.20x1.65	190.5	158.8
3.0"	76.20/72.90x1.65	228.6	177.8
4.0"	101.60/97.40x2.11	304.8	231.8

DT-4.1.3-3[a](DT21)

Hygienic Clamp Joint: Concentric & Eccentric Reducer

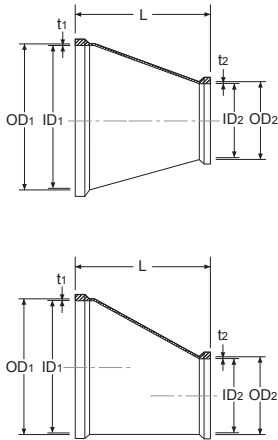

Size (Inch)	OD1 / ID1 x t1	OD2 / ID2 x t2	L
0.75"x0.5"	19.05/15.75x1.65	12.70/9.40x1.65	50.8
1.0"x0.5"	25.40/22.10x1.65	12.70/9.40x1.65	63.5
1.0"x0.75"	25.40/22.10x1.65	19.05/15.75x1.65	50.8
1.5"x0.5"	38.10/34.80x1.65	12.70/9.40x1.65	88.9
1.5"x0.75"	38.10/34.80x1.65	19.05/15.75x1.65	76.2
1.5"x1.0"	38.10/34.80x1.65	25.40/22.10x1.65	76.2
2.0"x0.5"	50.80/47.50x1.65	12.70/9.40x1.65	139.7
2.0"x0.75"	50.80/47.50x1.65	19.05/15.75x1.65	127.0
2.0"x1.0"	50.80/47.50x1.65	25.40/22.10x1.65	127.0
2.0"x1.5"	50.80/47.50x1.65	38.10/34.80x1.65	76.2
2.5"x1.5"	63.50/60.20x1.65	38.10/34.80x1.65	127.0
2.5"x2.0"	63.50/60.20x1.65	50.80/47.50x1.65	76.2
3.0"x1.5"	76.20/72.90x1.65	38.10/34.80x1.65	177.8
3.0"x2.0"	76.20/72.90x1.65	50.80/47.50x1.65	127.0
3.0"x2.5"	76.20/72.90x1.65	63.50/60.20x1.65	76.2
4.0"x1.5"	101.60/97.40x2.11	38.10/34.80x1.65	282.6
4.0"x2.0"	101.60/97.40x2.11	50.80/47.50x1.65	231.8
4.0"x2.5"	101.60/97.40x2.11	63.50/60.20x1.65	181.0
4.0"x3.0"	101.60/97.40x2.11	76.20/72.90x1.65	130.2

DT-4.1.2-3(DT25)

Hygienic Mechanical Joint: Short Outlet Run Tee

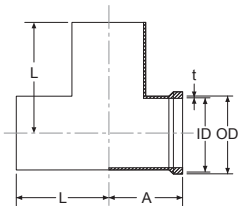

Size(Inch)	OD/IDxt	A	L
0.5"	12.70/9.40x1.65	22.2	47.6
0.75"	19.05/15.75x1.65	25.4	50.8
1.0"	25.40/22.10x1.65	28.6	54.0
1.5"	38.10/34.80x1.65	34.9	60.3
2.0"	50.80/47.50x1.65	41.3	73.0
2.5"	63.50/60.20x1.65	47.6	79.4
3.0"	76.20/72.90x1.65	54.0	85.7
4.0"	101.60/97.40x2.11	69.9	104.8

DT-4.1.3-3[b]

Hygienic Clamp Joint: Concentric & Eccentric Reducer

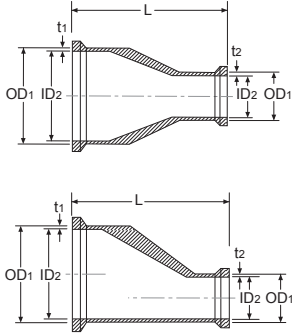

Size (Inch)	OD1 / ID1 x t1	OD2 / ID2 x t2	L
0.75"x0.5"	19.05/15.75x1.65	12.70/9.40x1.65	79.4
1.0"x0.5"	25.40/22.10x1.65	12.70/9.40x1.65	88.9
1.0"x0.75"	25.40/22.10x1.65	19.05/15.75x1.65	79.4
1.5"x0.75"	38.10/34.80x1.65	19.05/15.75x1.65	101.6
1.5"x1.0"	38.10/34.80x1.65	25.40/22.10x1.65	88.9
2.0"x1.0"	50.80/47.50x1.65	25.40/22.10x1.65	111.1
2.0"x1.5"	50.80/47.50x1.65	38.10/34.80x1.65	88.9
2.5"x1.5"	63.50/60.20x1.65	38.10/34.80x1.65	111.1
2.5"x2.0"	63.50/60.20x1.65	50.80/47.50x1.65	88.9
3.0"x1.5"	76.20/72.90x1.65	38.10/34.80x1.65	133.4
3.0"x2.0"	76.20/72.90x1.65	50.80/47.50x1.65	111.1
3.0"x2.5"	76.20/72.90x1.65	63.50/60.20x1.65	92.1
4.0"x2.0"	101.60/97.40x2.11	50.80/47.50x1.65	158.8
4.0"x2.5"	101.60/97.40x2.11	63.50/60.20x1.65	136.5
4.0"x3.0"	101.60/97.40x2.11	76.20/72.90x1.65	127.0

DT-4.1.5-1(DT30)

Automatic Tube Weld: End Cap

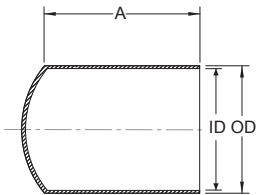

Size(Inch)	OD/IDxt	A
0.5"	12.70/9.40x1.65	38.1
0.75"	19.05/15.75x1.65	38.1
1.0"	25.40/22.10x1.65	38.1
1.5"	38.10/34.80x1.65	38.1
2.0"	50.80/47.50x1.65	38.1
2.5"	63.50/60.20x1.65	38.1
3.0"	76.20/72.90x1.65	44.5
4.0"	101.60/97.40x2.11	50.8

DT-4.1.3-2[a](DT26)

Hygienic Clamp Joint: Tube Weld Concentric & Eccentric Reducer

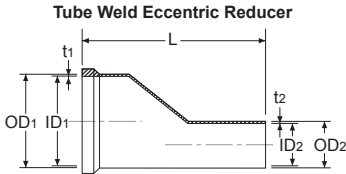
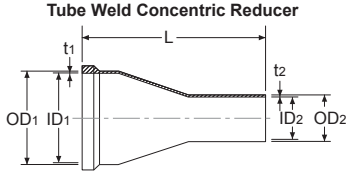

Size (Inch)	OD1 / ID1 x t1	OD2 / ID2 x t2	L
0.75"x0.5"	19.05/15.75x1.65	12.70/9.40x1.65	76.2
1.0"x0.5"	25.40/22.10x1.65	12.70/9.40x1.65	88.9
1.0"x0.75"	25.40/22.10x1.65	19.05/15.75x1.65	76.2
1.5"x0.5"	38.10/34.80x1.65	12.70/9.40x1.65	114.3
1.5"x0.75"	38.10/34.80x1.65	19.05/15.75x1.65	101.6
1.5"x1.0"	38.10/34.80x1.65	25.40/22.10x1.65	101.6
2.0"x0.5"	50.80/47.50x1.65	12.70/9.40x1.65	165.1
2.0"x0.75"	50.80/47.50x1.65	19.05/15.75x1.65	152.4
2.0"x1.0"	50.80/47.50x1.65	25.40/22.10x1.65	152.4
2.0"x1.5"	50.80/47.50x1.65	38.10/34.80x1.65	101.6
2.5"x1.5"	63.50/60.20x1.65	38.10/34.80x1.65	152.4
2.5"x2.0"	63.50/60.20x1.65	50.80/47.50x1.65	108.0
3.0"x1.5"	76.20/72.90x1.65	38.10/34.80x1.65	203.2
3.0"x2.0"	76.20/72.90x1.65	50.80/47.50x1.65	158.8
3.0"x2.5"	76.20/72.90x1.65	63.50/60.20x1.65	108.0
4.0"x1.5"	101.60/97.40x2.11	38.10/34.80x1.65	308.0
4.0"x2.0"	101.60/97.40x2.11	50.80/47.50x1.65	263.5
4.0"x2.5"	101.60/97.40x2.11	63.50/60.20x1.65	212.7
4.0"x3.0"	101.60/97.40x2.11	76.20/72.90x1.65	161.9

DT-4.1.2-5(DT27)

Hygienic Clamp Joint: Short Outlet Tee

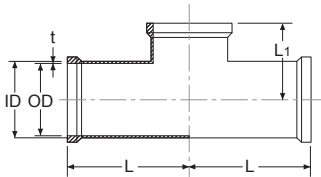

Size(Inch)	OD/IDxt	L	L1
0.5"	12.70/9.40x1.65	57.2	25.4
0.75"	19.05/15.75x1.65	60.3	28.6
1.0"	25.40/22.10x1.65	66.7	28.6
1.5"	38.10/34.80x1.65	73.0	34.9
2.0"	50.80/47.50x1.65	85.7	41.3
2.5"	63.50/60.20x1.65	92.1	47.6
3.0"	76.20/72.90x1.65	98.4	54.0
4.0"	101.60/97.40x2.11	120.7	69.9

DT-4.1.3-2[b]

Hygienic Clamp Joint: Tube Weld Concentric & Eccentric Reducer

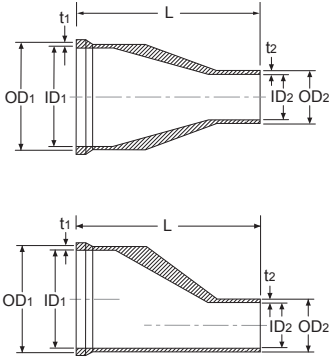

Size (Inch)	OD1 / ID1 x t1	OD2 / ID2 x t2	L
0.75"x0.5"	19.05/15.75x1.65	12.70/9.40x1.65	66.7
1.0"x0.5"	25.40/22.10x1.65	12.70/9.40x1.65	76.2
1.0"x0.75"	25.40/22.10x1.65	19.05/15.75x1.65	66.7
1.5"x0.75"	38.10/34.80x1.65	19.05/15.75x1.65	88.9
1.5"x1.0"	38.10/34.80x1.65	25.40/22.10x1.65	76.2
2.0"x1.0"	50.80/47.50x1.65	25.40/22.10x1.65	98.4
2.0"x1.5"	50.80/47.50x1.65	38.10/34.80x1.65	76.2
2.5"x1.5"	63.50/60.20x1.65	38.10/34.80x1.65	98.4
2.5"x2.0"	63.50/60.20x1.65	50.80/47.50x1.65	76.2
3.0"x1.5"	76.20/72.90x1.65	38.10/34.80x1.65	120.7
3.0"x2.0"	76.20/72.90x1.65	50.80/47.50x1.65	98.4
3.0"x2.5"	76.20/72.90x1.65	63.50/60.20x1.65	79.4
4.0"x2.0"	101.60/97.40x2.11	50.80/47.50x1.65	146.1
4.0"x2.5"	101.60/97.40x2.11	63.50/60.20x1.65	123.8
4.0"x3.0"	101.60/97.40x2.11	76.20/72.90x1.65	114.3

DT-4.1.4-1(DT22)

Automatic Tube Weld: Ferrule

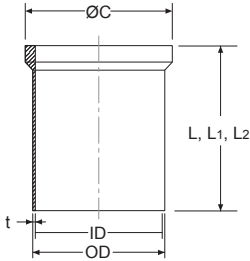

Size(Inch)	OD/IDxt	ØC	L	L1	L2
0.5"	12.70/9.40x1.65	25.0	12.7	28.7	44.5
0.75"	19.05/15.75x1.65	25.0	12.7	28.7	44.5
1.0"	25.40/22.10x1.65	50.5	12.7	28.7	44.5
1.5"	38.10/34.80x1.65	50.5	12.7	28.7	44.5
2.0"	50.80/47.50x1.65	64.0	12.7	28.7	57.2
2.5"	63.50/60.20x1.65	77.5	12.7	28.7	57.2
3.0"	76.20/72.90x1.65	91.0	12.7	28.7	57.2
4.0"	101.60/97.40x2.11	119.0	15.9	28.7	57.2

DT-4.1.2-10(DT28),DT-4.1.2-11(DT29)

Automatic Tube Weld: Instrument Tee Weld End/Clamp End

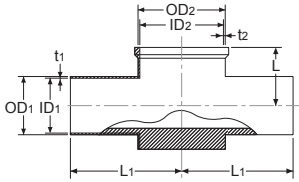

DT-4.1.2-10 (DT28)

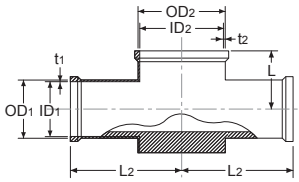

DT-4.1.2-11 (DT29)

Size (Inch)	OD1 / ID1 x t1	OD2 / ID2 x t2	L	L1	L2
1.5"x0.5"	12.70/9.40x1.65	38.10/34.80x1.65	22.2	63.5	76.2
1.5"x0.75"	19.05/15.75x1.65	38.10/34.80x1.65	25.4	63.5	76.2
1.5"x1.0"	25.40/22.10x1.65	38.10/34.80x1.65	28.6	63.5	76.2
2.0"x0.5"	12.70/9.40x1.65	50.80/47.50x1.65	25.4	69.9	82.6
2.0"x0.75"	19.05/15.75x1.65	50.80/47.50x1.65	28.6	69.9	82.6
2.0"x1.0"	25.40/22.10x1.65	50.80/47.50x1.65	31.8	69.9	82.6
2.0"x1.5"	38.10/34.80x1.65	50.80/47.50x1.65	38.1	69.9	82.6

DT-4.1.5-2(DT31)

Solid End Clamp Cap

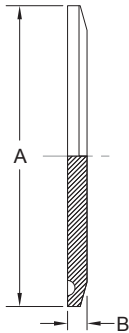

Size(Inch)	A	B
0.5"	25.4	4.75
0.75"	25.4	4.75
1.0"	50.5	6.35
1.5"	50.5	6.35
2.0"	64.0	6.35
2.5"	77.5	6.35
3.0"	91.0	6.35
4.0"	119.0	7.92